

BEST CONTACTS FOR YOUR SUCCESS



**Telegärtner**

KARL GÄRTNER GMBH

---

NETWORKING COMPONENTS

---

COAXIAL CONNECTORS

---

CABLE ASSEMBLIES

---

PRECISION TURNED PARTS

---

PLASTIC INJECTION MOULD PARTS

---

INDUSTRIAL ELECTRONICS



DataVoice

**Mini Distributors MPD**

# Mini-Distributors MPD

Small networks with a limited number of subscribers require simple and cost-efficient networking solutions. By means of Telegärtner's Mini Distributor series MPD users aren't forced to use large and expensive cabinets or enclosures for their passive network infrastructure. The MPD







series is suitable for any type of small network size. The distributors are available for 6, 8, 12, 16 or 24 links (shielded or unshielded) and can be affixed to the wall, onto a cable duct, onto a mounting rail TH35 (DIN EN 60715) or simply placed onto the desk.

## Modular Mini Distributors

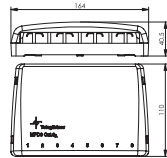
The modular Mini Distributors perfectly allow to install as much as passive network infrastructure as currently needed with the option for future network extension in the same housing. Additional shielded or unshielded keystone jacks of any performance category can be added or replaced at any time, unpopulated cut-outs can be closed using blank covers. The all new MPD12 & MPD16 even do allow to be snapped-onto a mounting rail (DIN Rail TH35) with its built-

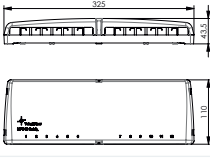
in adaptors, so no more accessory needed for this type of installation saving material costs and installation expenses.

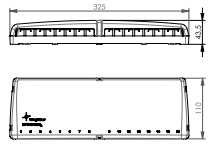
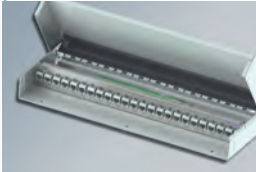
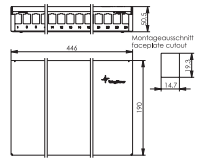
Features and benefits
<ul style="list-style-type: none"> <li>For 6, 8, 12, 16 or 24 keystone jacks (Modules and Couplers)</li> <li>Port identification</li> </ul>

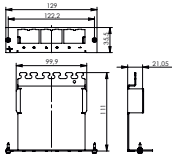
Mini Distributor	Order no.	Description	Colour
 	H02000A0103	MPD8 AMJ/UMJ TH35/AP Mini Distributor for 8 AMJ/UMJ Modules/Coupler, w/o Module/Coupler mounting onto DIN Rail TH35 without adaptor	alpine white
<b>New</b>  	H02000A0106	MPD12 AMJ/UMJ TH35/AP Mini Distributor for 12 AMJ/UMJ Modules/Coupler, w/o Module/Coupler mounting onto DIN Rail TH35 without adaptor	alpine white
<b>New</b>  	H02000A0107	MPD16 AMJ/UMJ TH35/AP Mini Distributor for 16 AMJ/UMJ Modules/Coupler, w/o Module/Coupler mounting onto DIN Rail TH35 without adaptor	alpine white
 	H02025A0260	MPD24 AMJ/UMJ Mini Distributor for 24 AMJ/UMJ Modules/Coupler, w/o Module/Coupler including cable strain relief	pure white RAL 9010
 	H02025A0233	6 Port Module Carrier 3 HU / 7 PU for AMJ-S Modules	aluminium

Modules	AMJ-S Module 2G Cat.6A	AMJ-S Module Cat.6A	AMJ Module K Cat.6A	UMJ Module K Class E <sub>A</sub> 500
Colour coding	Order no.	Order no.	Order no.	Order no.
T568 A (pack of 6x2 pcs.)	J00029A3000	J00029A2000	J00029K0036	J00029K0050
T568 B (pack of 6x2 pcs.)	J00029A3001	J00029A2001	J00029A0077	J00029K0078
T568 A (blister of 24 pcs.)	J00029A3110	J00029A2110	J00029L0036	J00029L0050
T568 B (blister of 24 pcs.)	J00029A3111	J00029A2111	J00029B0077	J00029L0078

# Mini Distributors LSA+

The Mini Distributors using LSA+ terminal blocks with 6, 8, 12, 16 or 24 ports supporting the performance of Category 6A form the basis for a network infrastructure with data transmission rates up to 10 Gbit/s. They further allow at least 750 mating cycles with standard compliant RJ45, RJ11, RJ12 plugs. Remote powered devices can be easily plugged into the MPD and supplied with data and power as PoE+ (acc. IEEE 802.3at) is also supported. The MPD LSA+ types are available as types for wall-mount, mounting rail TH35 and 3 HU chassis.

## Features and benefits

- Types for 6, 8, 12, 16 and 24 ports
- Cat.6A acc. to ISO/IEC 11801
- Real-time Re-embedded
- Easiest installation using LSA+ terminal blocks, colour coding T568A and B
- Equipotential bonding cables can be connected by M4 screw (shielded types)

Mini Distributors		Order no.	Description	Colour
		J02021A0051	MPD6-HS K Cat.6A Mini Distributor shielded mounting onto DIN Rail TH35 w/o adaptor	light grey RAL 7035
		J02021A0050	MPD6-HS K Cat.6A Mini Distributor shielded mounting onto DIN Rail TH35 w/o adaptor	alpine white
		J02021A0053	MPD6-H K Cat.6A Mini Distributor unshielded	light grey RAL 7035
		J02021A0055	MPD6-HS K Cat.6A Mini Distributor shielded including 2 mounting rail adaptor TH35	metal zinc-plated
		J02021A0030	MPD8-HS K Cat.6A Mini Distributor shielded mounting onto DIN Rail TH35 w/o adaptor	alpine white
		J02022A0053	MPD12-HS K Cat.6A Mini Distributor shielded	light grey RAL 7035
		J02022A0052	MPD12-HS K Cat.6A Mini Distributor shielded	alpine white
		J02022A0054	MPD12-H Cat.6A Mini Distributor unshielded	light grey RAL 7035
<b>New</b> 		J02022A0067	MPD16-HS K Cat.6A Mini Distributor shielded mounting onto DIN Rail TH35 w/o adaptor	alpine white
		J02023A0053	MPD24-HS K Cat.6A Mini Distributor shielded including cable management	pure white RAL 9010
		J02021A0054	MPD6-HS K Cat.6A 3 HU / 7 PU Mini Distributor shielded	anodized aluminium
		J02022A0055	MPD12-HS K Cat.6A 3 HU / 10 PU Mini Distributor shielded	anodized aluminium
		J02022A0056	MPD12-H K Cat.6A 3 HU / 10 PU Mini Distributor unshielded	anodized aluminium

## Example for Implementation

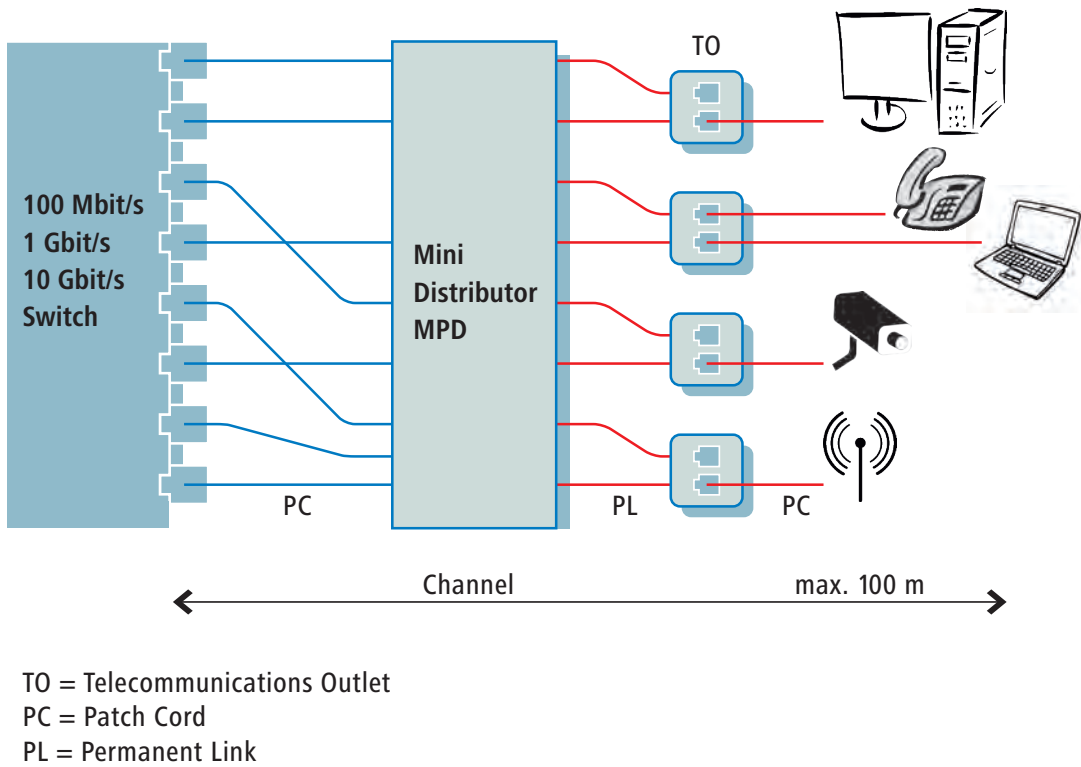

**Telegärtner**  
**Karl Gärtner GmbH**

Lerchenstr. 35  
D-71144 Steinenbronn

Telefon: +49 (0) 71 57/1 25-0  
Telefax: +49 (0) 71 57/1 25-5120

E-Mail: [info@telegaertner.com](mailto:info@telegaertner.com)  
Web: [www.telegaertner.com](http://www.telegaertner.com)

Your distributor: